

WOLFBOX

Drive on. Always on.

G840H

MIRROR DASH CAM

User Manual

wolfbox.com

The information in this manual is subject to change without notice.

Content

Precautions	3
Warnings	3
Product Overview	4
Warranty	4
Product Specifications	5
Package Contents	6
Appearance	7
User Interface Overview	8
Function Overview	9
Play on APP (About WIFI and APP)	14
How to Play Using a Computer	15
Installation	17
Trouble Shooting	23
Customer Service Center	25

Precautions

1. For further inquiries, please contact our customer service via email at contact@WOLFBOX.com.
2. Please use original accessories to avoid compatibility issues and insufficient current supply from non-compatible accessories. For example, 2-in-1 or 3-in-1 cigar sockets will not provide enough current to the device.
3. Please do not tamper or splice the rear camera wire for the purpose of extension, as the rear image/feed to the display may be lost. The length of the included cable for the rear camera is 20 feet, and is suitable for most types of cars.
4. If you wish to use a micro SD card with a capacity > 32GB, Please change the micro SD card [Class10 (10MB/s) required] format to FAT 32 on PC (a 32GB card is included in the package).

Warnings

- Keep small accessories out of the reach of children. If this product is damaged or malfunctions, stop using it immediately and contact WOLFBOX support. Continued use may cause fire, electric shock or, vehicle failure.
- This product is intended to be used as reference material in the event of an accident. We do not guarantee its effectiveness or admission as complete evidence.
- Please note that this product may infringe on privacy and other rights depending on how it is used. We are not responsible for any cases where this product infringes on privacy or other rights.
- This product is for DC12V/24V vehicles only.

- The specifications and appearance of this product are subject to change without notice for improvement.

Product Overview

- Thank you for choosing WOLFBOX G840H Mirror Dash Cam. This product provides a high-quality image and captures irrefutable evidence in the event of an accident, and records the beauty along the way for you.
- WOLFBOX is a professional automotive supplies manufacturing company. We have worked in the field of dash cams for more than ten years. We have a team of experienced and imaginative engineers who are committed to building a reliable and trustworthy automotive supplies brand.

Warranty

- We are committed to giving customers the best product experience and after-sale service.
- Our warranty period is one year. If the machine parts are damaged or there are any problems during use, we will solve them in time and provide you with a satisfactory shopping experience.

Note: The specific warranty period is subject to local laws.

- Please contact us with your online order, and we will provide free replacement and lifetime technical support.
- **Free extended warranty service:** After registering information on WOLFBOX.com, you may extend the warranty for an additional 6 months free of charge.

URL: <https://wolfbox.com/pages/warranty-form>

Product Specifications

RAM	DDR3 2GB	Display Type	IPS
Video Format	TS	Image Format	JPG
Front Camera	2.5K(1440P)	Rear Camera	1080P
Display Size	12"	Rear Lens FPS	25 fps
Power Interface	USB Type-C	GPS	External, 3.5mm headphone interface
Wi-Fi Connection	Supported	Photograph	Supported
Operating Temperature	-4° F ~158° F	Full Touch Screen	Supported
SD Card	Included 32GB Micro SD Card, Max Support 256GB		

Package Contents

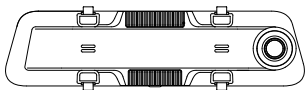

• 1440P Mirror Dash Cam

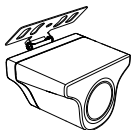

• 1080P Rear Camera



• GPS

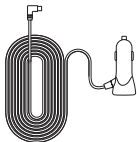

• Power Supply Cable with Car Charger

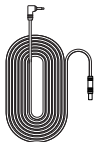

• Rear Cam Cable



• 3M Adhesive



• 32GB TF Card

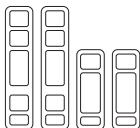

• Rubber Straps*4

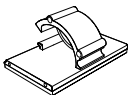

• Cable Clips*5



• User Manual

Appearance

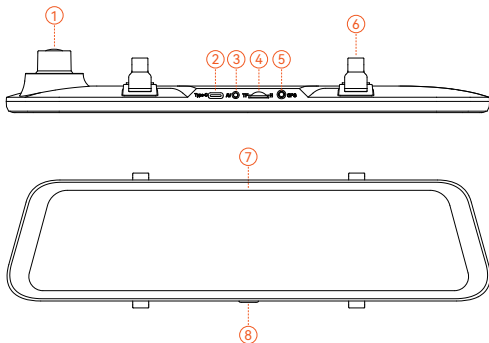

NO.	Name	Description
1	Lens	Front lens, records the front view of the car
2	USB Type-C Port	Port for power supply/connection
3	Rear camera connector	Port used to connect the rear camera
4	TF card slot	Provides expandable storage (class 10 Max 256GB)
5	GPS connector	Used to connect GPS module (GPS function requires optional GPS antenna)
6	Fasteners	The machine can be held in position with 2 straps
7	Display screen	12" touch screen display
8	Power button	Short press to wake up/sleep, long press to power on/off

User Interface Overview





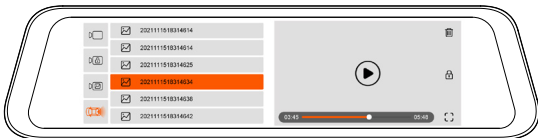

icon	Description
	Speed & Driving Direction: Once GPS is connected, the proper information will be displayed
	Date & Time
	Start / Stop Recording
	Snapshot: Take a Snapshot
	Recording Status: Flashing yellow indicates Lock-Recording (The recorded video will not be overwritten)
	Turn on/off audio recording
	Adjust the screen brightness
	Switching between front, rear and split-screen camera view
	File Playback: Playback the video & photo
	Settings: Tap to enter the settings menu

• Playback Mode



When you power on the dash cam, it will start recording automatically. Click/select  to enter playback mode.

















	Normal Recording		Photo
	Locked Videos		Switch Front or Rear Cameras







Function Overview



Click the setting icon to enter the function menu, where you can adjust various functions and parameters of the entire machine.

Function	Option	Description
 Resolution	2.5K+1080P /1080P+1080P	Video resolution selection.
 Movie Clip Time	1min/2min/3min	Adjust the loop recording duration.

Function	Option	Description
 Reversing Line	/	Adjust the length, width and angle of the reverse line.
 Mirror Flip of Rear Image	ON/OFF	The rear camera view is flipped horizontally.
 Upside Down of Rear Image	ON/OFF	The rear camera view is flipped vertically.
 Format SD Card	OK/Cancel	The SD card needs to be formatted for the first use. After long term use, you should format the SD card to clean it up.
 Language	English/Français/ Deutsch/ Italiano/Español/ Português/.....	Select your preferred language.
 Screen Saver	OFF/1min/ 2min/3min	If you do not touch the screen for the set time, the screen will turn off, but the device will continue to record.
 G-Sensor Sensitivity	OFF/High/ Medium/Low	After a collision/impact is detected, the device locks the recorded video.

Function	Option	Description
 Volume Setting	OFF/High/ Medium/Low	Adjust the volume.
 Flicker	50Hz/60Hz	Select screen flicker frequency according to national regulations.
 GPS Information	/	Displays latitude and longitude, GPS signal strength and other information.
 Clock Setting	Y/M/D/H/m/s	Time setting for year, month, day, hour, minute, and second.
 Time Style	12H Time Style /24H Time Style	Choice of 12-hour or 24-hour format.
 Time Zone	/	Select the corresponding time zone according to different countries or regions.
 Daylight Saving Time	ON/OFF	When daylight saving time is turned on, the time is advanced by 1 hour.

Function	Option	Description
 Speed Unit	KMH / MPH	Select the speed unit you need.
 Speed Compensation	5/3/1/0/-1/-3/-5	Since the speed obtained by GPS will be biased, it can be calibrated through this setting.
 Over Speed Remind	OFF/ Speed Choice	Set a speed limit, and the dash cam will emit a warning sound if your car exceeds it.
 Default Booting Display	Split Screen /Front camera /Rear camera	Set options to determine the screen display when the device is turned on.
 Reset Setup	OK/Cancel	Clears all presets and restores factory settings.
 Product Information	Software version & official website URL	Software version & official website URL

Function	Option	Description
 Help Center	After-sales service website & QR code	After-sales service website & QR code
 Wi-Fi	ON/OFF	Connect your mobile phone to Wi-Fi to use the app to view, download, edit, and share video files from your dash cam anytime.
 Parking Mode	OFF/12Hours /24Hours	When the Hardwire Kit is connected, you will find: 12H /24H parking modes available to choose from.

Note:

Parking Mode requires a hardware kit (purchased separately) in order to activate.

With the hardware kit connected and Parking Mode enabled, the dash cam will enter Lapse Recording mode when the car turns off. This mode captures video at 1 frame per second until the set duration ends or the car battery voltage drops below 12V.

Play on APP (About WIFI and APP)

The Wi-Fi feature has been designed so you can pair your dash camera wirelessly with your smartphone and access your recordings instantly from the dash cam. Here you can view, download and share your videos easily with your friends and family.

The app “WOLFBOX” is a free app that allows you to operate this WLAN built-in drive recorder from your smartphone.

• How to connect Wi-Fi?

1. Download the “WOLFBOX ” app

Go to the following address to download the “ WOLFBOX” app: <https://wolfbox.com/app/> You may also use your smartphone to scan the QR code to go to the download page.



2. Enable Wi-Fi

Go to Settings to turn on Wi-Fi. Go to Settings to turn on the Wi-Fi. Then, the device screen will display the Wi-Fi name and password.

3. Connect Wi-Fi

To connect your iPhone or Android phone to the G840H's Wi-Fi network, go to Settings > Wi-Fi and select G840H Wi-Fi. Then, enter the default **password: 12345678**.

4. Open the “WOLFBOX” app

Once your mobile phone is connected to the G840H's Wi-Fi network, open the WOLFBOX app. The camera will sync automatically, and you should see the live video feed on your phone.

- **Edit and share Your Videos in the App**

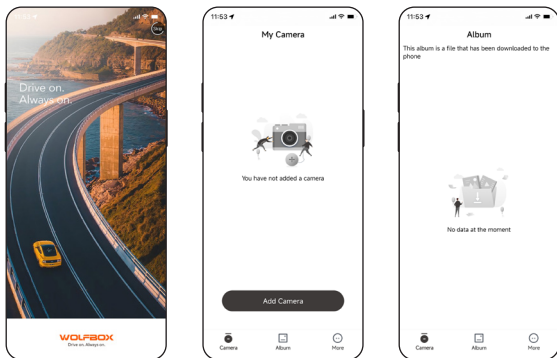

In the app, you can view and edit downloaded local albums and share them with others.

How to Play Using a Computer

We recommend the application “GPS Media Player” to watch and play dash cam videos, and view Google Maps.

You can download it for free on Mac or Windows from the following link: <https://wolfbox.com/gps-player/>

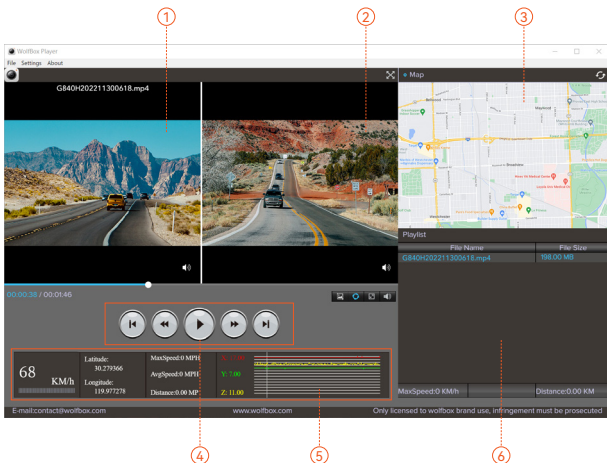

- ① Video play window (Front)
- ② Video play window (Rear)
- ③ Map and track display
- ④ Play control panel
- ⑤ Speed and driving state indication
- ⑥ Play list

Note:

If you record the front and rear dash cam videos simultaneously and add them to the playlist, you can play them side by side in split-screen mode.

To play a video file, drag and drop it onto the video player.

Installation

Before installing your dash cam, please test its functionality with all accessories and change the default settings to your preference.

• SD card installation

Ensure that the dash cam is powered off when inserting or ejecting the SD card.

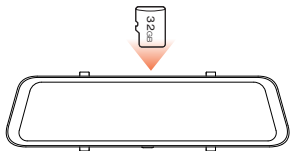

• The Front view of the host

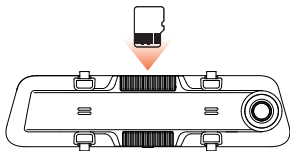

• The Back view of the host

• Unit installation

1. Place the head unit (WOLFBX Mirror) on the rear-view mirror by hand, and be sure to separate the silicone brackets on both sides of the rearview mirror. Buckle the device to the rearview mirror with the rubber straps. Adjust the front lens to a desired angle.

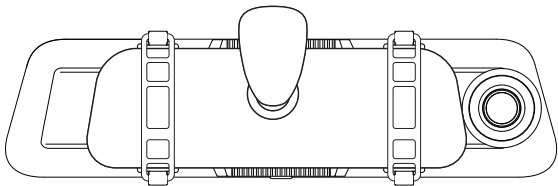

2. Connect the car charger to the charger adapter to supply power for the dash cam.

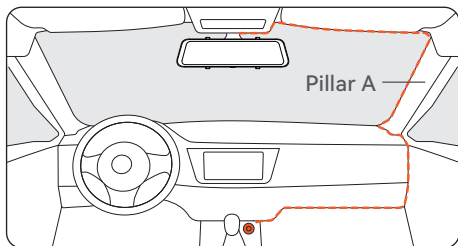

• Power ON/OFF

- Short press the power button to turn on, long press the power button to turn off.
- When using the car charger, if the cigarette lighter port is ACC, the dash cam will automatically turn on when the car is started.

• Rear camera installation

If you don't need to adjust the angle, you can remove this iron plate.

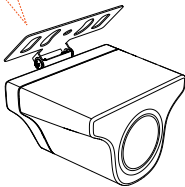

- Outside the car bracket

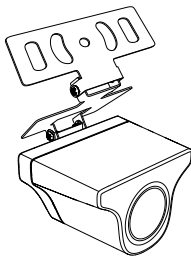

- Inside the car bracket

• Rear Camera Wiring Instructions

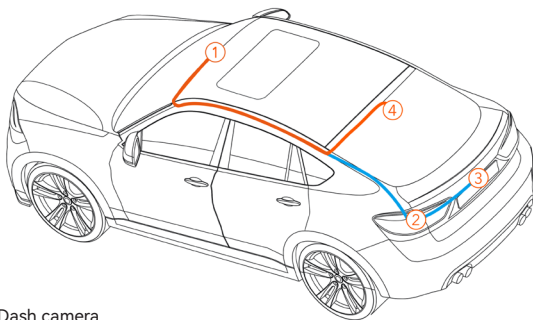

① Dash camera

② Connected to reversing light

③ Outside the car bracket

④ Inside the car bracket

Note:

The rear camera has two wire routing options, both of which conceal the wire along the edges of the door.

1. Connect the rear camera cable to the mirror

Plug the rear camera cable into the AV interface of the unit.

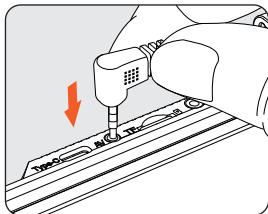

2. Rear camera cable routing

Route the rear camera cable to the rear of the car, leaving some slack. Insert the cable into the gap in the front windshield and along the upper end of the door using the included tool.

If you choose to install the rear camera inside your car, fix it on the rear windshield after routing the wiring.

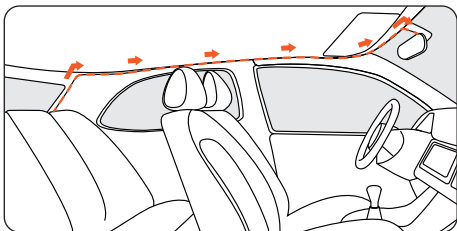

3. Remove the panel

Open the trunk and remove the interior panel that covers the other side of the license plate mount area. Use a trim removal tool or other thin device to pry the panel open.

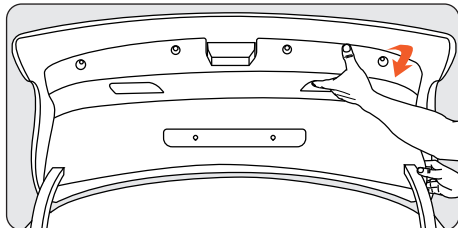

4. Fix the rear camera and connect the cables

Fix the rear camera near the license plate light with 3M glue, and connect the rear camera cable through the license plate light hole to the rear camera cable.

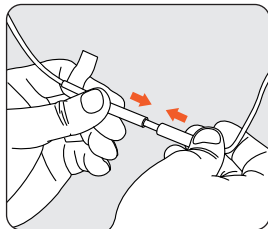
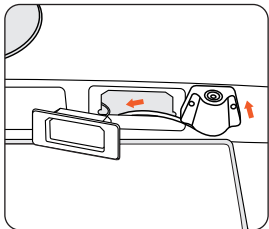

5. Connect the red wire to the reverse light's positive terminal

Find the positive terminal of the reverse light. This is the terminal that has voltage when the car is in reverse gear. To find it, step on the brakes, put the car in reverse gear and measure the voltage at each terminal. The terminal with voltage is the positive terminal. Strip the positive cable and wrap it with the red cable from the camera. Insulate the connection with electrical tape. Test the connection by putting the car in reverse gear and seeing if the dash cam enters reverse mode.

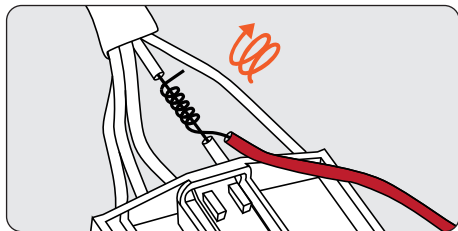

• GPS Installation

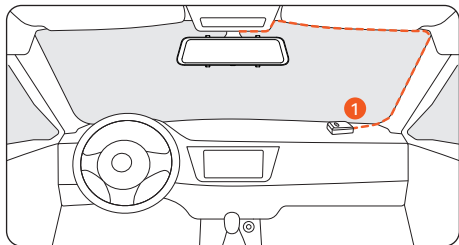

Position 1:

Install the dash cam in the right corner of the central console and hide the wiring along the edge of the front windshield using double-sided tape.

- Considering the use effect and installation convenience, we usually recommend customers install it at position 1.
- You may also test different locations for the dash cam to find the one that works best for you. Just make sure that the black side is facing up to receive the GPS signal.
- Once the GPS is installed, the GPS icon on the home screen will appear. After the GPS signal has been received, the device's GPS will show direction and speed.



Trouble Shooting

- **Can the Wi-Fi feature be obtained by upgrading the firmware?**

The G840H Wi-Fi is a hardware upgrade from a previous version, and its Wi-Fi feature cannot be available through a firmware upgrade.

- **Can rear camera images be transmitted wirelessly?**

The G840H Wi-Fi comes with a rear camera cable through which the rear camera video is transmitted. The Wi-Fi feature is only used to connect the phone to the dash cam.

- **Is it possible to monitor the vehicle remotely via Wi-Fi on the G840H?**

Considering the limited Wi-Fi range, it is not possible to monitor the vehicle remotely via the App connecting to G840H.

- **Rear camera image blurred or not detected?**

For "Blurred rear image" issue, please make sure that the protective film on the lens is removed and wipe the lens with a cleaner. If the focusing issues are caused by high temperatures, please contact us for support.

If you are getting a "Rear camera not detected" error, check the AV input on the top of the mirror and the rear camera cable for damage, especially at the connector.

- **How to connect the unit to App via Wi-Fi?**

1. Please make sure that Wi-Fi is turned on manually in settings.
2. Search for "WOLFBOX" in the app store to download the latest version of the app.
3. Check the Wi-Fi list on your smartphone to see if the network named "WOLFBOX" can be found.

4. If the app displays "Connection Failed", please find "Get Support" in the app to contact us.

Customer Service Center

If you have any problems with the function or installation, please contact us with any questions.



Help Center



WhatsApp



For more information:

✉ contact@wolfbox.com

🌐 www.wolfbox.com

💬 <https://wolfbox.com/contact-us>

WOLFBOX

Drive on. Always on.

Check us out here!
Product and service are the foundation of WOLFBOX.

Email: service.wolfbox@gmail.com

Phone: +1 888 296 8399



www.wolfbox.com